

Aircraft Wiring for Smart People

~ A Bare-Knuckles How-To Guide ~

12 July 2008

Abstract

This is a step-by-step, *Foolproof 100% Gonna Work* guide to wiring your airplane simply, effectively and inexpensively that builds on one basic principle: people who build airplanes are smart folks who can do things. This booklet is about how to make our electrical systems simpler and easier to install.

Introduction

Flying around the country installing EFIS and Autopilot systems I've met a lot of builders. I've hung out in their shops, drank their beer and wired a lot of airplanes. I've also heard the same questions about how and when to use certain techniques, what to ground and what not to ground, how to size breakers and switches, whether to crimp or solder, and why some antennas pick up Radio Moscow but not the local AWOS.

This booklet will show you how to wire your airplane so that it will work right the first time and teach you enough of the How's and Why's so that you know what you did and why you did it. This isn't about all the possible ways to accomplish the job – it's about one, *Foolproof 100% Gonna Work* way. The idea here is to find a method that'll work in all cases, and just cop out and use that method instead of trying to make everyone into an engineer. (There are only so many the world can stand!)

It's also time for a change. With few exceptions, homebuilts are wired like WW II fighters, and electronics have come a long way in 60 years. A two-year-old laptop may be old news, but up in the cockpit its still 1939. Take a moment and think about a modern car compared to a modern light plane. A single keyswitch and automatic overload protection versus a stack of breakers and switches and a bundle of wiring to choke a horse. Does your car have an Avionics Master switch for its half dozen computers and on board FADEC? How do we build satellites that MUST work and can't be serviced on-orbit? Starting to look more like 1939 at the airport all the time, huh?

Circuit protection can be made automatic, switches can serve as indicators, and less panel clutter means Easier To Use. We can do better, and as an industry we generally do.

Note on the title: I adore the "Dummies" books, but figured anyone who can build an airplane, and stick with it to the point of wiring up systems is no dummy. Besides, they'd probably sue.

Table of Contents

ABSTRACT	1
INTRODUCTION	1
TABLE OF CONTENTS	2
HOW TO USE THIS BOOKLET	4
START HERE	4
12 OR 24 VOLTS?.....	4
HOW MANY BATTERIES?.....	5
ONE ALTERNATOR OR TWO?	6
FIREWALL CONNECTORS.....	6
FULL AUTO, NO MANUAL	7
STEP BY STEP, PIECE BY PIECE	8
ELECTRICAL THEORY, JUST A QUICK BIT	8
<i>Voltage</i>	8
<i>Current</i>	9
<i>Power</i>	9
<i>Resistance</i>	9
<i>RF and Noise</i>	10
POWER AND GROUND	11
<i>The Evil Ground</i>	11
<i>Sizing Wires and Breakers</i>	11
RADIOS AND INDICATORS	12
ANTENNAS.....	12
<i>Kinds of Antennas</i>	12
<i>Safety Note About Transponder Antennas</i>	14
<i>Spotters Guide to GPS Antennas</i>	14
<i>GPS Antenna Mounting Tips</i>	15
ELECTROMAGNETIC COMPATIBILITY	16
AUDIO AND ENTERTAINMENT	16
<i>Back to Grounding, Again</i>	16
<i>Shielding</i>	17
<i>No Common Paths</i>	17
EFIS, ENGINE MONITORING AND OTHER DIGITAL DEVICES.....	18
<i>Computers Make Noise</i>	18
<i>CPU, Magnetometer and Display Wiring</i>	18
<i>Control Wiring</i>	18
<i>The Evil Ground, Again</i>	18
<i>Engine Wiring</i>	19
<i>Engine Start</i>	19
Introducing SEPIC.....	19
<i>Notes on Magnetometers</i>	21

Iron	21
Wiring	21
Level and Square.....	21
TOOL TIME!.....	22
SOLDER AND FLUX.....	22
ROHS	22
HEAT SHRINKABLE TUBING.....	22
SNAKESKIN	23
DIGITAL VOLT OHMMETER.....	23
AUTOMATIC WIRE STRIPPER.....	23
FLUSH CUTTING DYKES.....	24
COAX STRIPPER FOR BNC CONNECTORS	24
DANIELS CRIMPING TOOL.....	25
SOLDERING IRON	25
DESOLDERING PUMP.....	26
SOLDERLESS SPLICES AND TERMINALS.....	26
HOOKUP WIRE	27
<i>Size Matters</i>	27
<i>Color Is Better Than Black and White</i>	27
<i>Twisted Pairs Are Easy to Trace</i>	28
COAXIAL CABLE	28
CONNECTORS.....	29
<i>Power Connectors</i>	29
<i>Battery and Alternator Connections</i>	29
<i>Coax Connectors</i>	30
LEARNING TO SOLDER.....	30
FOOLPROOF 100% GONNA WORK POWER SYSTEM.....	31
POWER BOARD DESIGN.....	31
<i>Mounting the board</i>	32
<i>Master Switch and Ground</i>	32
<i>Alternator output</i>	33
<i>Choosing Switches</i>	34
THIS PAGE LEFT BLANK BECAUSE WE COULD WHERE TO GET PARTS, TOOLS, ETC. ...	35
WHERE TO GET PARTS, TOOLS, ETC.	36

How To Use This Booklet

According to my friend the Adult Education Expert, the way to get the most out of this booklet is to flip through it and look at the pictures, and see what looks interesting. Next, read the next section, entitled **Start Here**, and finally read through once to see what's what and get a feel for what we're going to talk about. Don't try to remember everything, just buzz through it like a story.

Once you've got a feel for the tools and the techniques at an overview level, work through the example in **Foolproof 100% Gonna Work Example** and cross-reference anything that doesn't make sense with the section that talks about it. Go ahead and make notes directly on the drawings – the PhD education types say that this is supposed to help a lot, and gives you and me an excuse to doodle in the margins.

Having read through, worked through the example, made your notes and re-read the stuff that didn't come in clearly the first time, you're ready to work out your own plan in the **Foolproof 100% Gonna Work Method**.

Pretty soon you'll be helping other guys with their projects, which is specifically what I have in mind. This is something that we, as a community, should be able to do well and eventually no one will read this booklet anymore. It'll be like building a fire, something someone shows you, that everyone on the trail knows how to do.

Start Here

These next topics are the decisions builders agonize over (and debate without end) when wiring their planes, so we'll get 'em out of the way first so we can get down to business and do some real work. The question to be answered is: "If we weren't already doing it this way, how would we *want* do it?" This will give you a good idea of where we'll be headed in the rest of the booklet, so let's take a look.

Warning: There are many Right ways to do something, and infinitely many Wrong ones. Without starting another jihad with Uncle Bob, let me say right up front that what follows are my opinions as a degreed Electrical Engineer, and although I might be wrong, at least I'm wrong in the company of thousands of others engineers. Blame Dr. Leach and Co. at Ga Tech. He taught me most of this stuff.

12 or 24 Volts?

Cars are twelve (12) volts, airplanes are twenty-four (24). There you go, easy enough.

As of this writing, just about anything you can buy in avionics will run on 10-32 volts DC and doesn't care either way. Single voltage items like landing lights and strobes can be all be had in 24 volt versions now, so that's a not an issue either. If you need a jump start, most FBOs are used to wheeling out the start cart for King Airs, Citations and such that are all – you guessed it – 24 volts.

Here's yet more detail for you:

1. Since a given load draws half the current at 24 volts that it does at 12, you can use smaller wire with the same results. You can use wire that's only $\frac{1}{4}$ the size, which is a pretty big deal when you're running #18 and everyone else is running #14. It's just dead weight, and the convenience of a single size for power is a pretty big deal.
2. Engine start will also drop a 12-volt system down to around 9 volts causing EFIS systems to reboot, radios to lose presets and fuel totalizers to restart. A 24-volt system will only drop to about 18 volts during engine start, which is well above the 10.5-volt minimum for modern, digital avionics. No backup batteries, no switching, no relays, and no fiddly, complex systems to solve a non-problem.
3. A 24-volt system also has a LOT more reserve energy *available for use* than a 12-volt system. As in point #2, a failed alternator in a 12-volt system leaves you 2 volts from shutdown. In a 24-volt system you've got a lot more reserve before your avionics and FADEC drop offline. Look at the discharge curves, and you'll see that a 12-volt battery at 11 volts is only partially discharged. A 24 volt battery at 11 volts is very close to dead.

The bottom line is the higher the supply voltage, the better off we're going to be up to a point where it starts to get dangerous. Quite a lot of telecom equipment runs on 48 volts DC, which is close to an optimal trade-off between voltage and safety. Don't laugh – you'll probably live to own a 48 volt car. If you have a hybrid, you already do. ☺

If you've got to go 12 volts, that's fine, no biggie. We've just got to allow for a small backup battery for your avionics to keep you up during engine start. Not a disaster, but not the first choice.

How Many Batteries?

If you go with 24 volts, that's an easy answer: One. There's a current fashion in backup batteries and essential bus designs, which I think is overkill. If you have a battery with enough grunt to start your engine, it'll run your avionics for longer than you can remain aloft.

The real issue is if there's a main bus fault or short, then everything drops and you're in trouble, right? Traditionally that's true, but there's a simple way around it:

Provide multiple busses, not multiple power sources!

Just like your house, car and computer, multiple busses and breakers solve the problem, not multiple power sources. How many people do you know who have more than one Power Company feeding their house?

If you have a 12-volt system, you'll need a small backup battery to give you some margin of reserve, but that's easily done, and doesn't weigh all that much.

EXCEPTION: If you plan to do serious hard IFR flying it's also nice to have an Essential bus with a small battery wired in to keep your critical items lit up during a major power system fubar. For VFR flying, which is most experimental aviation, there's just no need. It's more dead weight.

One Alternator or Two?

One is plenty for almost all applications. If you have a good Alternator and regulator (I like the B&C stuff, it works well and the support is outstanding) the most likely reason for failure is bad wiring or overload. Either way, bringing another alternator on-line will probably just feed the fire. There are several popular designs that use multiple alternators in single engine aircraft. I don't see the advantage in real, actual use. It's a little silly for a single engine craft.

If you have a big, 24 volt battery as discussed above, why bother with a backup alternator? The battery will carry your avionics and engine systems for hours. The only exception would be if you had high current draw, critical loads like de-ice boots or a hot prop to keep running. In which case, you really do need a second alternator. Might be a good idea to hang it on a second engine if you're planning on a lot of that kind of flying!

Secondary alternators are a neat idea, but with a single engine it doesn't really buy you that much more time aloft, and buys you none at all when the engine quits.

Firewall Connectors

The time has come to go through a firewall, so how do we do it? By drilling a hole. There's a school of thought that favors swoopy, round, metal MIL-type connectors, and matching sub-harnesses but I've found that it takes a Swiss Watchmaker to put them on correctly, and then another day or two to find out which pin got wired wrong. You can usually tell by the burned smell but ... OK, that's not funny. Sorry about that. By building the whole airplane harness on the bench and dropping it in the airplane, there's no need to ever remove the harness. And how often do you take off your firewall?

Anything that is serviceable and removable should have it's own Molex Connector located close to it. What good is a big connector on the firewall when you need to pull your alternator or igniter box?

Just run the harness through the firewall, use a nylon bushing to make sure nothing scratches or chafes and you're all set. If you do avionics wiring for a living, round MIL-type connectors on the firewall *are* very pretty and yes, they are superior to just using a bushing and maybe a firewall shield. My contention is a homebuilder who will install three or four of them in his/her life will probably get two or three of them bugged up as part of the learning process.

What makes perfect sense in a production environment isn't always the best thing for hobbyists.

Full Auto, No Manual

War Story Time:

I've worked on a few homebuilts that are all but impossible to operate without recurrent training at Flight Safety every few months. On one very sexy homebuilt that rolled in to the shop you'd have to throw six (6) switches *and* press in four (4) breakers to get the EFIS to come up in normal operating mode. I never did understand the various emergency modes – they were beyond complex, and getting the sequence wrong could result in some expensive smoke.

My thought is simple: No manual overrides, cross-feeds or other Apollo-13-wanna-be switches in the electrical system.

Here's why:

Most private pilots fly less than 100 hours a year, and almost never practice system failure drills. If in an emergency “that which is not practiced is not performed”, there's real harm in putting complex manual features in an electrical system that can get you in more trouble than you had.

The first task in an emergency is to “Fly The Airplane”, which is probably a better idea than trying to remember how to bring another alternator on-line and cross feed your essential bus from a backup system while not blowing your remaining breakers. This sort of thing can be made automatic by simply designing for it, so there's no need for the manual overrides. How do they do it on cruise missiles and satellites where there's no one to operate the electrical system? The same way we're gonna do it here!

Step By Step, Piece by Piece



There are six (6) fundamental kinds of things you're gonna have to deal with when wiring:

1. Power and Ground
2. Radios and Indicators
3. Audio and Entertainment
4. Antennas
5. EFIS, Autopilot and Other Digital Devices
6. Engine Monitor, FADEC and Sensor Wiring

Each of these is a little different, and use different tools and connectors, so we'll cover them one at a time. If you run into something new, like Satellite Weather for example, you're ready. It's got a computer like and EFIS and an antenna like a radio. After the next few pages, you'll know what to do!

Electrical Theory, Just a Quick Bit

Before we get into how to do the work, we need a little theoretical basis. Just a very little bit, so stay with me.

Voltage

Everyone talks about voltage, but what is it, exactly? It's the electrical equivalent of pressure – a 12 volt spark jumps less than 1/8 inch, but a 12,000 volt spark will jump an inch or more. Voltage is pressure. Guidelines:

- A regular D cell battery is about 1.5 volts
- A car battery is 12 volts
- An airplane battery is supposed to be 24 volts, but some are 12 like cars
- Most avionics will run on anything between 10 and 32 volts.

Current

Current is measured in Amperes, or Amps, and is the electrical equivalent of flow.

Guidelines:

- A 12 volt radio draws about 3 amps
- A 12 volt landing light draws about 10 Amps
- A starter can draw 150 Amps or more (800 for turbines!)

Power

Power is measured in Watts and is simply Volts * Amps. How much current times how much voltage is how much power. Guidelines:

- A 24 volt landing light drawing 5 Amps is using $5*24 = 120$ Watts
- A 12 volt radio drawing 3 Amps is using $12*3 = 36$ Watts
- 1 Watt dissipated in free air is warm to the touch
- 10 Watts in free air will burn your fingers

Resistance

If Voltage is like pressure and Current is like flow, Resistance is just that -- resistance to flow. Resistance is measured in Ohms and is equal to Volts / Amps (how much pressure divided by how much flow). For a given voltage, the lower the resistance the more current will flow. Guidelines:

#18 wire has a resistance of 0.0064 Ohms per foot.
#22 wire has a resistance of 0.0161 Ohms per foot.
A good connection should read less than 1/2 an Ohm

Since the voltage measured across the wire is the Resistance of the wire times the Current flowing through it, you can see that you'll lose some voltage, *and* lose some precious power in your wiring. Take this example:

A 10 foot chunk of #18 is carrying 5 Amps to run our transponder. Ten feet of #18 has a resistance of 0.064 Ohms, which means we'll drop $0.064 * 5 = 0.32$ volts in *each* wire, both power and return. This means of the 12.5 volts you're sending to the transponder, the transponder only sees 11.86! Not a big deal, but when the battery gets low, it doesn't leave you a lot of margin. The voltage drop is only 1/4 as much at 24 volts, and you have a lot further to go, but I believe I beat that horse enough for one day.

To Review:

Power in Watts = Volts * Amps (Voltage across it times the current through it)
Volts = Ohms * Amps (Resistance of it times current through it)

Knowing this much, you can figure out just about anything in a DC circuit:

- What is the voltage drop in a 10 foot piece of #22 wire carrying 5 amps?

$$\text{Ohms} = 10 \text{ feet} * 0.0161 \text{ Ohms per foot} = 0.161$$
$$\text{Vdrop} = \text{Ohms} * \text{Amps} = 0.161 * 5 = 0.805 \text{ volts}$$

- How much power is lost in that wire?

$$\text{Watts} = \text{Volts} * \text{Amps} = 0.805 * 5 = 4 \text{ Watts (the wire would be warm touch!)}$$

- A 24 volt radio draws 5 amps on transmit. What is the equivalent resistance of the radio?

$$\text{Ohms} = \text{Volts} / \text{Amps} = 24 / 5 = 4.8 \text{ Ohms}$$

This means the radio acts just like any other 4.8 Ohm resistance.

This is good background, but since we're wiring power with #18 at 24 volts, and using 10 amp breakers on everything, you don't have to worry about it. It's handled, but now you know for your next engineer's cocktail party. Really. They talk like this.

RF and Noise

Everything we've talked about so far is DC (direct current) circuits, where a voltage drives a load of a known resistance. This covers 98% of aircraft wiring, and good thing too.

The other 2% are AC circuits, which you'll just hook up and otherwise not have to mess with. AC alternates between positive and negative and looks like a sine wave on a 'scope. Radios and digital devices are full of high frequency AC, and Radio Frequency AC is called "RF" for short. Shielding is used to keep RF inside, in the case of coaxial cable, or outside in the case of shielded audio circuits. By following this booklet, RF and noise suppression is something you can say you heard about, but don't have to deal with.

We'll cover it in detail when we get to Audio and Entertainment.

Power and Ground

First off, we've got to power the thing up, whatever it is, which brings me to Kirchoff's Law, which simply states that whatever electric current goes into something, has to come back out and return to the battery. Which means anything you power up needs two wires to make it go – one for Power and one for Return. This brings us to:

The Evil Ground

In a car or metal airplane some wise soul thought it would be a good idea to just use the chassis or fuselage as a common Return wire and save a few bucks. Great idea, if you want to spin motors and make lights blink in a Model T, but not so good for delicate electronics like EFIS, Radar, electronic engine monitors or FADEC. Both *Electronics International* and *blue mountain avionics* specify ungrounded EGT probes because most homebuilt airplanes have grounds all over the place and the stray currents that go with them can cause odd EGT readings.

“Bad Grounds” cause more problems than just about anything else.

So -- I offer the Zen solution of not thinking about things in terms of “grounds”. Ditch the whole, outdated, tragically useless concept. If you stick to the two-wire rule, one for power and one for return, you'll never have a ground problem, and everything you connect will work the first time. Remember, “Ground”, in this context, is convenient shorthand for the return lead in a circuit. This brings us to a simple rule of thumb:

All circuits are wired with a power lead and a return lead of the same size. Power is color-coded yellow or red, return is color coded black.

Color-coding is done in every branch of electronics except for light aircraft to make things easier. What were we thinking? We're gonna start doing it too.

Sizing Wires and Breakers

We did a fair amount of figuring in the section above, which we can reduce it down to a simple rule:

Breakers are 10A for everything wired with #18, which is almost everything.

If you have a load that draws more than 8 Amps, you need to put it on a separate breaker. There are *very* few of these in practice, generally alternator output, landing lights in 12 volt systems and some gear pumps. Breakers should be loaded to less than 80% of their capacity, so the rule holds.

8 Amps * 24 Volts = 192 Watts, which is quite a lot of power.

A common practice in homebuilding is to size the breaker to match the size of the load. This sort of makes sense, but when you think about it, it really doesn't. The breaker is protecting the wiring, not the device being powered! If the wiring shorts out, we want the breaker to pop instead of melting the wire – right?

But, you say, the automotive industry use different sizes of fuses!

True enough. They use different sizes of wire too, because auto fuses are all one price while copper wire is priced per pound used. What makes good sense in high volume production isn't always the best method for one-off projects. For us homebuilders, simple and safe is what we're after so we should do things a little differently.

Radios and Indicators

This covers wiring everything from a basic Nav/Com to EFIS, Autopilots and Radar. The signals you'll be dealing with here are low level (less than a volt) and are susceptible to noise and interference. Wire all of these with #22 Teflon wire, and shield microphone, headphone and speaker leads. Shields are to be connected at the radio end **only**, and cut flush at the other end using your Flush Cutters. Power and Return are #18 in the usual colors.

The manufacturer provides a standard drawing for the radio and indicator you bought, the only thing I can add is this:

Make sure you leave enough cable length to be able to take the indicator out of the panel and still connect and run it. These sloppy lengths of cable are called Service Loops and make the mechanic's life easier and your bill lower when it comes time to fix it.

Anything you build, imagine having to take it apart and fix it later!

Antennas

Antennas are used to couple one circuit to another at a distance. Anyone who says otherwise is probably selling something. What we want in airplanes is to couple our transponder to a ground controlled radar station, to couple our Com radios to other Com radios and to get our Nav radio hooked up to the local VOR. Antennas come in a bewildering array of choices, so I'm gonna show you which kinds work 100% of the time with no problem and save you what DAR Robert Harris would call the "Learning Experience".

Kinds of Antennas

There are three frequency bands of interest for airplanes: VHF, Microwave and Long Wave.

- VHF is for Nav, Com, Localizer, Glideslope and Marker beacons. All the 1950's era about-120-MHz stuff you tune with an aircraft radio. These antennas are connected with RG-142 or RG-400 coaxial cable and BNC connectors.

For a metal airplane use a commercial whip antenna and make SURE that the bottom of the antenna is connected to the skin of the aircraft. No paint, oil, or any other yuck. This needs to be a solid electrical connection. Take the end of the coaxial cable that goes to your radio, and measure with an Ohmmeter from the shield to the skin of the your airplane. It needs to be pretty close to a dead short, since the shield is bonded to the skin of the airplane at the antenna. Most antenna problems are caused by either connectors put on badly, or open shields. Check yours and make sure it's good.

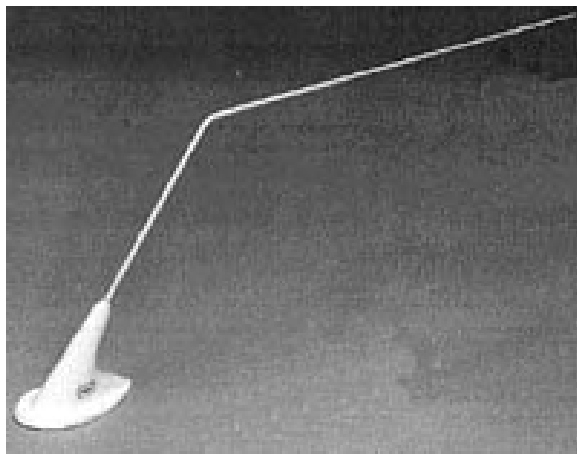

The antenna shown above is the AV17 from Aircraft Spruce and is commonly seen on Van's designs. I'm not pitching this one in particular, but they all generally look something like this.

For a composite airplane use a dipole. This is a vertical that has *another* vertical element to balance it since there's no metal aircraft skin to connect to it. These antennas always work, and almost never give problems.



The ones shown in the picture are from Advanced Aircraft Electronics, and work very well. Aircraft Spruce usually has them in stock. Just bond them in to the

airplane, and forget about it. Jim Weir has plans for making a similar antenna with copper foil, although I'm partial to the AAE version since it has a built-in balun.

Remember: COM is vertical, NAV is horizontal! Follow AAE's directions and you'll be in good shape.

- Microwave is for Transponder, Strike Finder, GPS, Satellite weather, Cellular phones and all the creations of the last few decades. These are typically connected with BNC connectors, but use RG-142 or RG-400 for lower loss at frequencies near 1000 MHz.

Microwave antennas are best supplied by commercial sources since their active elements are so small making them is a real chore. Most microwave antennae require a ground plane like an aluminum airplane skin under them to work properly. If you are installing one of these in a composite airplane, either ask the manufacturer for an antenna that will work in a composite bird with no ground plane, or spray a ground plane using Super-Shield.

Super-Shield is basically metal foil in a spray can. Shoot three (3) coats of it on the outside of the plane, mount your external antenna and it's just like having a metal airplane without all the rivets. You can even paint over the stuff once the antenna is installed and no one will be the wiser but us.

<http://www.mgchemicals.com/products/841.html>



Safety Note About Transponder Antennas

A transponder puts out a couple hundred Watt microwave pulse in a frequency band that is none too healthy to be around.

On a metal airplane this is no big deal, since the whole thing is one big, shielded can. On a composite bird, you can be sitting unpleasantly close to a powerful microwave transmitter, which is Not Good. Mount the antenna as far away as practical, or failing that, use metal foil or SuperShield to shoot a ground plane between you and the antenna. One of my friend's airplanes actually has the antenna right under the pilot's seat!

Spotters Guide to GPS Antennas

GPS antennas come in two flavors, active and passive. Active antennas take a voltage (usually 5 volts DC) up the coax to power a small preamplifier in the antenna. Most Garmin GPS antennas are this variety, as are any of the small, plastic stick-on types. Active antennas are small enough to put inside the airplane on the glare shield or in the composite structure and are often hidden. Passive

antennas are usually mounted on the skin of the airplane, and if the GPS receiver can has the gain to use them, can provide excellent performance.

If you're not sure which kind you have, or which kind to use, take your voltmeter and measure the voltage from the center conductor to the shell of the BNC connector on your GPS receiver. If you see about 5 volts, you're looking at an active antenna.

Most passive GPS antennas look like short circuits at DC and will short out a GPS receiver that is set to drive an active antenna. Best bet is to use the one the manufacturer sent with the radio.

GPS Antenna Mounting Tips

When mounting GPS antennas make SURE that there are no obstructions that block the sky. Imagine the bottom of the antenna sitting on a round plate ten (10) feet in diameter covered with a matching 10 foot dome. What's it gonna hit? If it's metal, that's a part of the sky you won't see. The vertical tail isn't wide enough to signify, but a chunk of glareshield or the top of the wing sure is!

Keep in mind that small but CLOSE is a problem. Imagine holding your hand in front of your face to blot out the sun. If you get close enough to your eye (the antenna) you can occlude quite a lot of sky with a small obstruction. I've seen GPS antennae clustered close together blocking out big chunks of sky and giving very mysterious results. Not what you want in your airplane, but fixing this kind of thing pays the rent at my place!

Common troubles are putting them partially under a metal glareshield, beneath carbon fiber, or in the cockpit of a high wing design. GPS can 'see' through fiberglass, but not carbon, and certainly not aluminum. Got it next to another antenna? That's a chunk of sky you'll miss too!

You should be able to see 10-12 GPS satellites while flying, but 6-8 is much more common, I've found. Taking a little time to locate the antenna where it has an unobstructed view of the sky will gain you a world of performance.

- Long Wave is for ADF. This is for tuning NDBs and AM broadcast stations and is the oldest of all the flying radios. Since the FAA is slowly killing off all the NDBs, we won't cover it here in detail. If you have to hook up an ADF, treat it like VHF and you'll be more than fine. Techniques that work at 150 MHz work admirably well at 1 MHz, and you can enjoy being part of a tradition as old as radio. Tesla invented it, and Marconi was ordered by the US Supreme Court to pay him patent infringement royalties for quite some time. Look it up. Yet more cocktail party fodder for when you get stuck on a desert island with a bunch of engineers.

Electromagnetic Compatibility

Now here's a field ripe for cocktail party conversation. EMC is the subtle art of making sure the signals in one system stay OUT of all the other systems. If antennas are designed to couple circuits at a distance, EMC is the science of making accidental antennas not work. A brief bit about accidental antennae:

The bare knuckles, rough and ready formula for a quarter wave whip antenna is $234/f$ where f is the frequency in MHz. Let's say about 120 MHz for us airband pilot types, right? That works out to be:

$224 / 120 = 1.95$, or just short of two feet. How inconvenient that most instrument panels wiring runs are about that long and thereby make dandy antennae for coupling all sorts of unpleasantness into our radios.

A square wave, according to the late Mr. Fourier, consists of a sine wave at the same frequency and an infinite number of odd-order harmonics. This means you can pick up radio noise at odd multiples of the generating frequency, too. This means an EFIS or Engine Monitor with a video clock at 8 MHz can cause all sorts of hash at 3,5,7,11 and other odd multiples of the fundamental frequency. Good grounding and bonding prevents almost all of it, and good design prevents the rest.

A short list of EMC things to do:

- Some GPS antennas have active electronics in them. Keep them away from each other, at least two (2) feet. Same for XM.
- Wire each device (radio, light, toaster oven) with two wires, the "grounds" all terminating at the same place.
- Use shielded wire for anything connected to a device with a display.

Which bring us directly to:

Audio and Entertainment

I rather enjoyed the look on my mechanic's face when she turned on the strobe pack and igniters and noticed that no difference in the Mozart playing in the headsets. "Jeez, that's quiet" she said. Same thing for radio transmissions "Sounds like FM" she says. There's no need for alternator whine, strobe noise or any other audio crackles and crunchies in an airplane any more than there is in a home theater system. Here's how you make it quiet:

Back to Grounding, Again

The guys at PS Engineering at just north of my shop in Tennessee are a sneaky bunch, I think. They put a solid ground bar on the back of their audio panels and ask you to solder

all the “grounds” right there. There’s a crew who isn’t going to have any problems with ground loops! This essentially forces your audio circuits to follow the same rule as all the others:

All circuits are wired with a power lead and a return lead of the same size.

This means that microphone, headphone, CD and everything else gets connected with two leads and that the Return leads are all connected to this audio “ground bar”. Doesn’t matter where or what Ground is, as long as all the wires go to that one place. The PS Engineering crew has a lovely drawing in their installation guide that worth looking at for an example of how to do things well.

Since we’re wiring our circuits in pairs, grounding is not a problem we have to solve anymore. There is no ground. We don’t do that.

Shielding

As mentioned in the section on RF and Noise, shielding is what we use to keep the wires from acting as antennas and either radiating or receiving unwanted RF. By using shielded wire for microphone, headphone, speaker and any other circuit carrying audio and connecting the shield to the ground buss described above you’ll essentially have no problems ever.

Make sure you connect the shield at the ground buss end and cut it off flush at the other end.

If you don’t the shielding won’t work and you’ll not be pleased. Which brings up a couple more rules of thumb:

If you want it quiet, give it it’s own lead and shield it.

Shields are connected at the source end, and cut off flush at the load end.

No Common Paths

Shielded leads will keep things separate, but that also means running separate cables for separate signals. Specifically, keep these signals on their own cables:

- Each headset
- Each microphone and PTT
- Each audio source (CD, cellphone, etc.)

- Speakers

This approach has you running a few more cables, but gets you the perfect result every time. You can use the same kind of Teflon insulated, shielded six (6) conductor cable for each of these. As an added bonus you'll use the same kind of cable for your engine sensors, so you'll get good at working with it.

EFIS, Engine Monitoring and Other Digital Devices

Just about everything in the digital age has a microprocessor in it, and although they sure make life easier in the cockpit they can be noisy and quirky to hook up if you're used to wiring lights and gear pumps. Here's how to keep the New Generation happy:

Computers Make Noise

A wise man once said that a square wave can be thought of as a pure tone with an infinite number of odd-order harmonics tossed in. Like all great legends, Fourier spoke only the truth and a switching waveform like those used in computer clocks spray RF like a firehose.

This RF noise gets into EVERYTHING if we don't keep the stuff bottled up. Most devices made for aircraft are built to hold the noise inside but just in case, we're gonna wire everything to make SURE it stays there.

CPU, Magnetometer and Display Wiring

CPUs and video displays should be powered with shielded cable to keep the noise level down. Connect the shield at the power source (driven end) as usual, and leave the other end open as usual. This keeps the noise inside the box where it belongs.

Control Wiring

Control leads like autopilot disconnects, resolvers and all the other usual avionic command and control can be run with plain old wire. Twist them together to make a bundle and let it go at that. These signals are high level enough to be fairly noise immune.

The Evil Ground, Again

Lots of digital electronics have floating power supplies, which is to say that connecting the Power and Return leads doesn't necessarily mean you've got a "Ground" for anything else.

A common example is a Oil Temperature probe that has one wire – where's the ground? The old mechanical gauge expected the ground to come back through the engine block like in a car, which isn't gonna happen in a carbon fiber airplane.

On our EFIS/One units we run CHT probes with two leads to each sensor for this very reason. You know that if you wire both leads there's no question that the current is flowing where you think it is.

Engine Wiring

Wiring in the engine compartment is simple with an Engine Pod form BMA, or similar devices from other makers. The trick here is to think about working on these sensors later, not how sexy and swoopy they'll look all tied up with no access.

Ask yourself:

- If your EGT, CHT or Oil Pressure isn't working where do you attach the meter?
- If you want to replace one sensor, do you have to cut everything else apart?
- Did you keep the low voltage sensitive bits away from the high-frequency bits?

Simply thinking about keeping RPM, N1 and anything else that pulses away from sensitive things like thermocouples will help a lot. Pressure sensors that require power to operate ("three wire" sensors) have high-level signals that are very noise-immune. Single wire or two-wire resistive sensors are not as insensitive. Hey, sometimes insensitivity IS a good thing ...

Engine Start

There's a lot of good reasons to not go 24 volt and avoid the whole "everything drops out" effect when you start your engine. The most common of them is that you've already got a bunch of 12 volt stuff, or that Van's only supplies flap motors in 12 volts, that style of thing. Is there a way around this? Sure!

Introducing SEPIC

SEPIC stands for Single Ended Primary Inductance Converter and is proof positive that Electrical Engineers have no sense of humor. So, SEPIC it is. What these circuits do is take a DC voltage between 4 and 28 volts and make 12 out of it. Did that get your attention? Check this out:

The LM 3478 is a chip from National that, with the appropriate parts around it, can take 4 – 28 volts in and give you a nice clean 12 volts out at 10 amps. That'll run your avionics during engine start, and allow you to use some of the energy left in the battery when voltage drops below 10 volts.

Here's a typical SEPIC circuit using the LM3478 to make 5 volts. A few tweaks and a bigger MOSFET and we've got what we need!

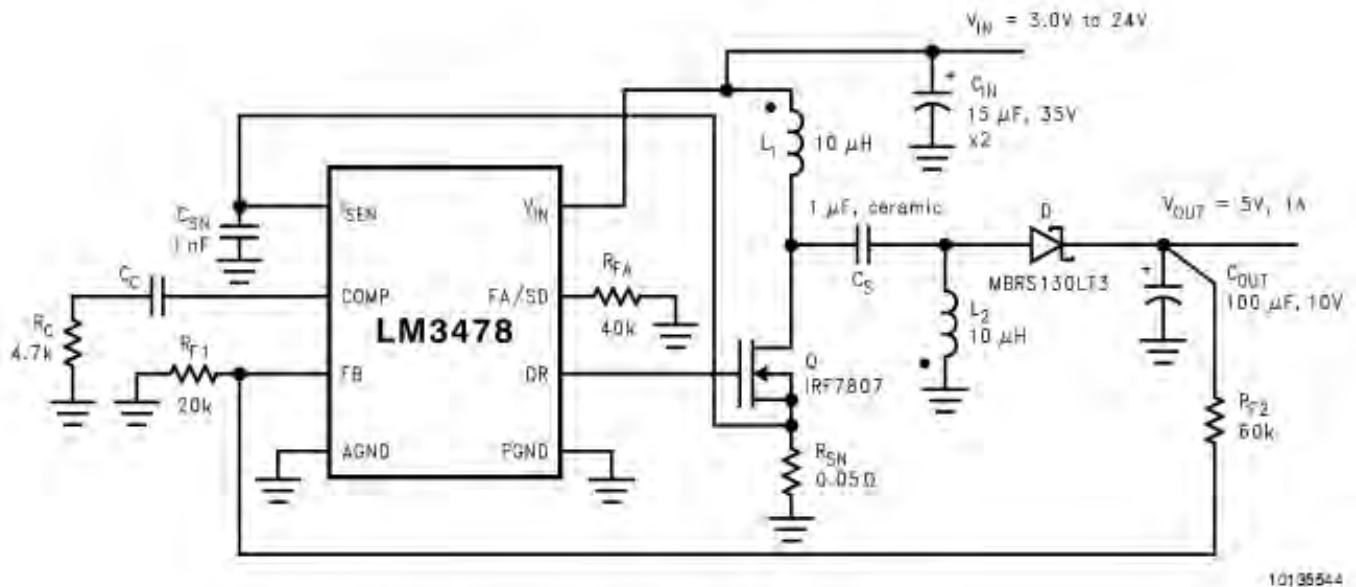

FIGURE 12. Typical SEPIC Converter

The parts to wire up the circuit above can be had for less than \$50 bucks, not counting the circuit board and a box to put it in which are the expensive bits, oddly enough. The actual LM3478 is less than a buck! This is the kind of circuit you see a lot in automotive use, and in telecom. We should be seeing more of it in homebuilt airplanes, and if there's enough interest I'll make up a board for it.

4-28 volts in, 12 volts out at 10 amps. What's not to like?

Notes on Magnetometers

Wiring to magnetometer should be shielded since they are CPUs, just little ones, and they can be horribly noisy depending on who made them. Magnetics in aircraft suffer from a few common maladies, most of which we can fix easily:

- Too close to IRON
- Too close to wiring
- Not level fore/aft and left/right

This covers magnetics from *blue mountain*, King, Crossbow, anyone.

Iron

Ferrous metals disturb magnetic measurements. This means no nuts, bolts, washers, nutplates or anything with the word Steel in it within 18" of the magnetic sensor. The bigger the mass or iron (canopy rail, engine block) the further away you need to be. A good rule of thumb is 18" from small stuff, four (4) feet from big stuff.

Stainless steel is questionable, depending on the iron content of the alloy and how it was treated. Best bet is to treat it like Steel and keep it away. You DID use brass or nylon to mount the magnetometer, right? I've seen quite a few working poorly mounted with AN hardware which is, of course, made of the finest Made-in-USA steel and magnetic as North.

Wiring

Any conductor carrying current throws a magnetic field. Keep these 18" away and you'll be fine.

Level and Square

Make sure that the magnetic sensor is mounted level left to right and fore and aft. A 2 degree error here will induce 2 degree errors in turns!

Tool Time!

Before we get into the How's and Why's, we need to get familiar with the tools we'll be using and the materials we'll be using them on. Read on – it's a lot simpler than you'd expect, and all of this stuff can be had from the sources at the back of this booklet.

Solder and Flux

Traditionally, good solder comes as a spool of soft wire and is 63% Lead and 37% Tin called, not surprisingly, 63/37 solder. The flux that fills the hollow core of the solder cuts through the oxide layer on your wire and connector so that the solder will wet out and flow easily. Kester 44 is a good one, and comes in 18 Gauge for big stuff, and 23 gauge for fine work.

You'll sometimes here the term "rosin core solder" which generally means any solder that has a non-acid organic flux core. The stuff I prefer cleans up with water, and the smoke won't sting your eyes when you solder with it.

For soldering big lugs for your battery and alternator leads the flux core in the solder may not be enough. Kester makes a good liquid flux that rinses clean with water. We'll cover this in detail in the soldering section, but we *do* wash everything in water to remove excess flux and leave a clean, shiny joint. By the time you get through this booklet you're gonna be *good* at this!

RoHS

This term, pronounced Row-Hass for those ever-frequent EE parties, means Reduction of Hazardous Substances which is electronics speak for Lead-free. Lead is a bad thing, and eventually it'll be on the list with plutonium, PCBs, cigarettes and Scotch whiskey of banned and deadly substances. Lead-free solder does have it's problems, though, and tin-whiskers growing out of the joints is one of them. You'll never have to worry about it, but eventually you'll have to use it, and there's essentially no downside for big, hand-soldered joints. The old 63/37 lead/tin stuff is slowly going away, but it's still good stuff (better, actually) if you can still get it.

Buzzwords to look for: Water soluble, organic flux, lead-free.

So get the lead out! Sorry, had to be said.

Heat Shrinkable Tubing

This stuff is great – solder a connection, sleeve it in heat shrink, and it's airtight and good as gold. We use heat shrink for covering splices and the ends of uninsulated connectors. The good stuff has glue inside that melts when you heat it up to form both a water and airtight seal, like 3M EPS-300. Digikey P/N EPS333-16K is one size of this tubing, which is available in many sizes.

Snakeskin

This knitted cable covering make the difference between an OK and an exceptional looking installation. Put your spun leads inside this, and you're on your way to a truly gorgeous, and easily repaired, airplane.

Digikey P/N AG120NF12B-100-ND is made by Alpha Wire and looks like this:

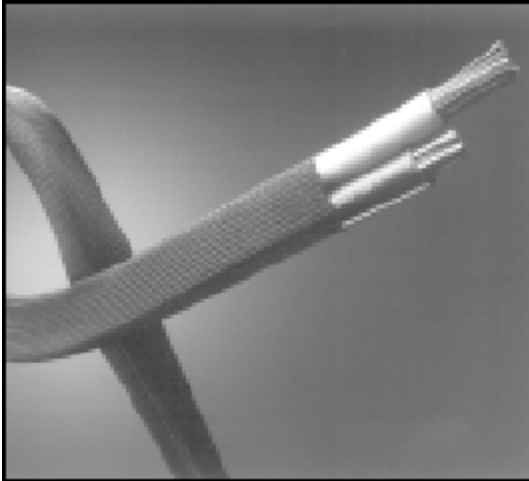

Digital Volt Ohmmeter

You don't need anything super-duper here, but you do need something that can measure DC Volts, Ohms and has a continuity checker that beeps. Anything else is gravy for this kind of work. I'm very partial to Fluke, but then again I'm an EE and use my DVM like an A&P uses a wrench. Harbor Freight has what you need for less than \$50. Make sure:

- The thing is digital
- That it autoranges – you should be able to read it without having to remember to multiply by 10 or 100 or whatever.
- That it doesn't have a zero adjust for the Ohms ranges: good ones are automatic
- That it has a diode checker – they almost all do this now, and it's a nice feature
- It has a beeping continuity tester – you'll use this a lot
- \$50 will get you a decent one, \$150 will get you a great one, \$300 will get you the one I use in the lab that has a laptop port and a book full of useless features.

Automatic Wire Stripper

An automatic wire stripper saves time, money and frustration and is cheap, cheap. Nicked wires caused by bad manual stripping are about half of the broken connections I see, and this thing makes sure you get it right every time. There are various different

types to fit every budget. The one pictured below is very nice, and can be had from Digikey or Allied.



Flush Cutting Dykes

These are the normal ‘wire cutters’ that everyone uses with a twist – they make a flush cut with no burr. It’s the avionics tech’s secret weapon for a really nice job. Make sure you get a good set with cushioned handles and a spring that pops it open when you let go. Makes a real difference in fatigue at the end of the day. Don’t let anyone cut safety-wire with these – the jaws are not hardened to cut steel wire, and it’ll nick them badly and they won’t cut clean anymore. My personal favorite is from Xcelite, and is a full flush cutter. Fry’s or Digikey has ‘em for about \$6. The Cooper is shown below:



Coax Stripper For BNC Connectors

These nifty little gizmos strip the outer jacket, copper braid and inner insulation on coaxial cable in one go, and are available from several makers in varying price ranges. You won’t be doing too many BNC connectors, but for what it costs it’s cheap insurance that your connectors will all work right the first time. Failing that, borrow one from the avionics shop or cable TV guy.

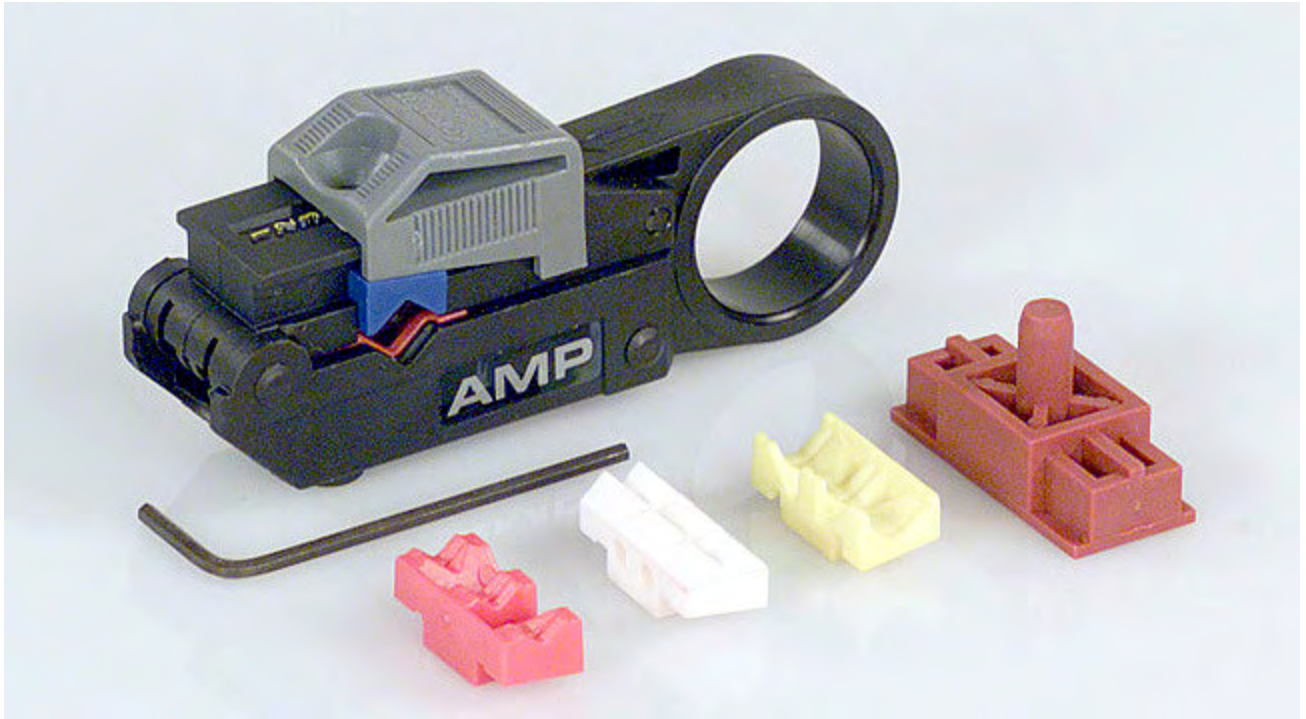

Daniels Crimping Tool

This is the one to use for all the D sub connectors you see on avionics. If you are farming this out, you don't need it. These tools make a perfect crimp every time and are pretty expensive. It's worth borrowing one for as little as you'll use it, but use it you must, as there is no substitute.



Soldering Iron

You'll need a good soldering iron in the 35 Watt range. As usual, Digikey, Allied or any of the other should have what you need. A common one looks like this:



Desoldering Pump

You'll need one of these for things you solder together and discover you didn't mean to. Digikey P/N PAL1700-ND is a good one, about \$20

Solderless Splices and Terminals

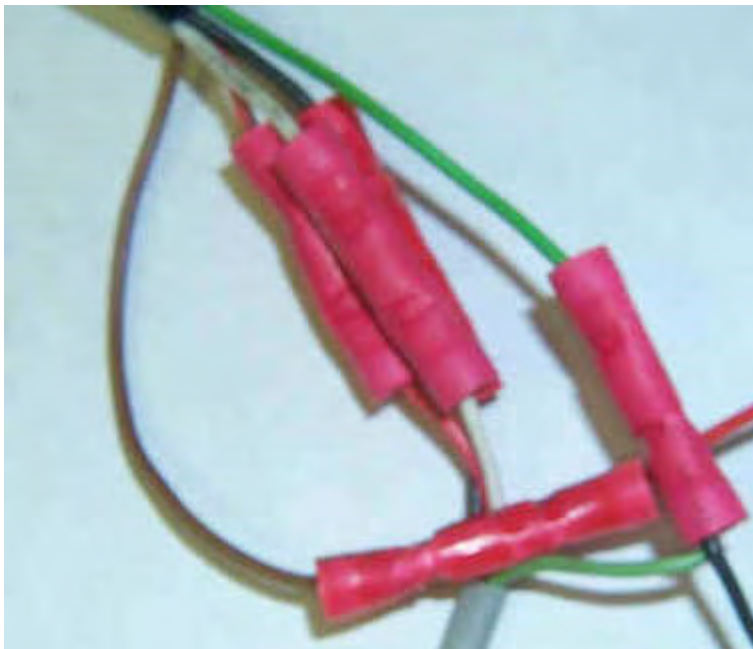

The automotive-style splices are HORRIBLE. Don't use them for anything except filling a dumpster. In the hands of a real pro they can be just fine, but none of the pros I know use them, oddly enough.

If you need to make a connection, solder it and cover it with shrink tube.

I've spent more hours chasing bad Butt Splices and under-crimped Ring Terminals than I'd care to count. Soldering takes a

little more time, but once it's done, it's done well and completely and that's the last you'll ever mess with it.

These are very popular, but here's why I say pitch 'em in the dumpster:

1. A homebuilder won't use enough of them to get good at putting them on
2. You can't inspect them to see if the wire is cut, over-crimped or broken
3. These splices are, very often, used to cover-up a mistake that should be rewired anyway. Note the color code changes at the splice in the photo above. Makes for a long afternoon, somewhere.

A friend's Cozy had FOUR of these things in a two-foot power lead. Took us hours to find the intermittent problem caused by one of them, and another 30 minutes to properly cuss the shop that did it. Just say no!

Hookup Wire

Everyone knows that Tefzel insulated wire is white, and you wire airplanes with it. As you might expect by now, I'm gonna disagree. Why make everything white? Can we possibly make the airplane any harder to work on? And why Tefzel? Tefzel and Teflon are chemically similar, except that Teflon handles cold better, is impervious to almost everything, doesn't burn or outgas and is available in a zillion colors. Satellites are wired with Teflon. General Aviation aircraft are still wired with Tefzel. You know why? Because once we start doing something that works, we keep doing it!

The point is, use multiple colors. You can get Tefzel and Teflon both in various colors now, so we might as well use them. I like Teflon since it can take more heat – the insulation doesn't creep when you solder it – and since it is not gas-permeable. Take your pick, but pick it in color!

Size Matters

With the exception of your starter and alternator cables, you only need two sizes of wire in your airplane: #18 and #22. #18 is good for 10 amps, and anything smaller than #22 can be hard to work with unless you do it every day. The rule is:

Use #18 for Power and Return, #22 for everything else.

Color Is Better Than Black and White

The following colors of Teflon wire to make things easy to trace and work on later.

Color	Meaning
Yellow	Power (ships power)
Red	Power (device power)
Black	Return
Blue	Signal
Green	Signal
White	Signal

The rule is “the brighter the color, the higher the voltage” so Alternator output is Yellow while Alternator field is red. Both are power colors. Black is always return (ground if you must call it that!) and Blue, Green and White are used for signal leads as needed.

Example:

A tachometer sensor needs power, return and a signal output lead. I chose Red, Black and White. Just looking at the sensor on the engine I can tell which lead is which, and I don’t have to figure out how to keep wire labels from coming off under the cowl as time goes on and things get oily. Makes it easier!

Twisted Pairs Are Easy to Trace

If you are going to have two or more wires going to a single device, I say spin ‘em. Use an electric drill to twist them into a cable that’ll stay together and you’ll be amazed how much neater your bundles look, and how much easier it is to tie all this stuff down.

Just take your bundle, clamp one end in a vise, stretch them all parallel and fold your end over and twist. Put that twist in your electric drill and spin ‘em up. After they look like you want, give a gentle tug to stress relieve the bundle, and it won’t snap back when you let go.

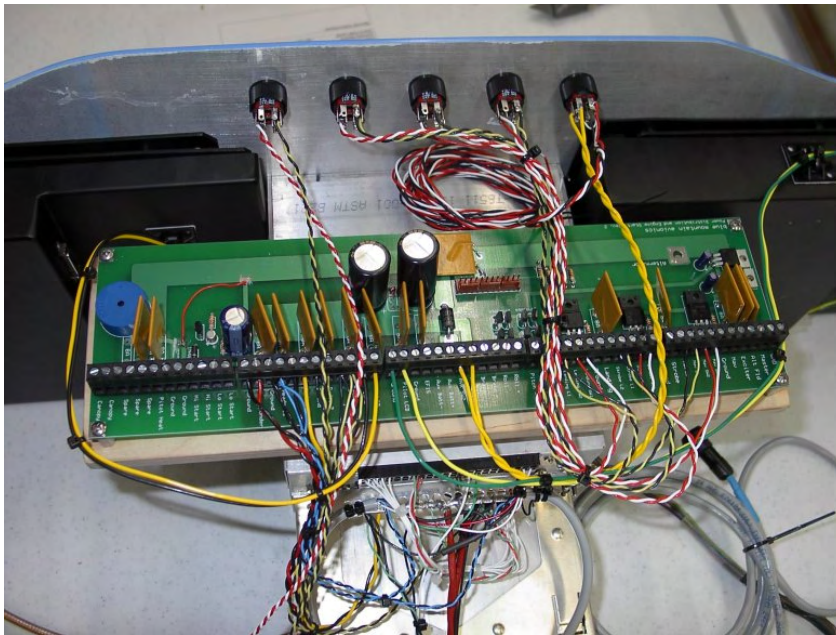

Spun cable sets and power board prototype in N722

Coaxial Cable

Coax comes in several flavors, but to make matters simple and keep your tool investment to a workable minimum we’ll just pick one: RG-142. This is the copper-colored coax that avionics shops usually refer to as “The Good Stuff” and use on transponders and radar antennas. It’s the same as RG-58 in every way except it’s better: higher

temperature, lower loss, everybody wins. You can use it on anything from GPS to ADF and it'll work just fine.

RG-142 is a bit more money than RG-58, but you'll usually come off cheaper wiring one airplane with all RG-142. Check this out: If you're buying a minimum length roll of 250 feet of cable, you've got more than you need anyway. If it's cheaper to buy just one roll of the good stuff! RG-58 also doesn't shield as well, so it's worth it to use RG-142. I can't tell you how many 'noisy' airplanes we've fixed by just using decent coax.

RG-142 is equivalent to RG-400 for our purposes. RG-400 has a stranded center conductor, but for our uses they're equivalent.

Connectors

Power Connectors

The ubiquitous "Molex Connector" shows up all over the place. Your Whelen strobe packs have 'em, and every A&P in America has a box full somewhere. Molex makes a world of connectors (it's almost like saying "Timken Bearing"), but the ones aircraft people call "Molex Connectors" have three wires in them and go by these numbers:

Male Plug	03-09-2032	Pin: 02-09-2103
Female Receptacle	03-09-1032	Pin: 02-09-1104

These take the little pins specified above. The pins can be crimped on, and the ones above are good for wire sizes 14 – 20, which means our #18 fits perfectly. Use these to hook up strobe packs, trim motors, anything you may have to take out and fix, fiddle with or replace. These are used on certified aircraft, and are pretty easy to work with.

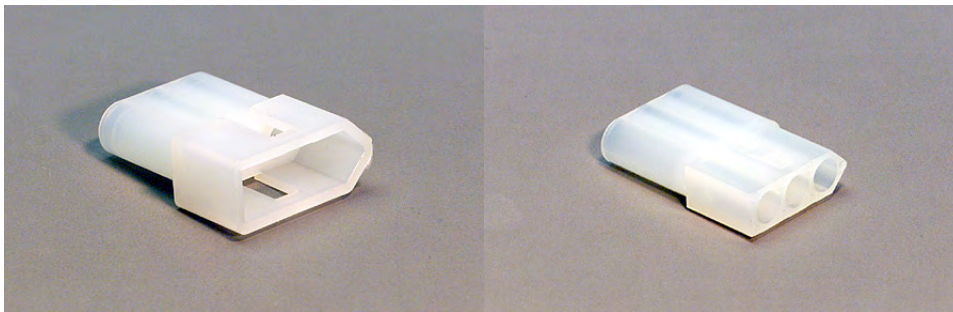

Battery and Alternator Connections

Big power leads like battery cables should have big lugs sweated on with a torch. Yup, with a torch. Dunk the lead in flux, heat it up and tin the exposed copper. Put some flux in the lug, get it hot and stick the tinned lead in. Add solder until the lug is full. The connection will be low resistance, won't corrode and will look good. Wash the whole thing in water to remove any residual flux and put shrink tube over the whole shooting match to relieve the stress point where the solder made the wire solid.

First, take your solder and run off about 20 feet of it. Loop it around your hand and elbow like a rope and make 10 loops. Twist until you've got a thick bundle of solder. You can also buy bigger stuff, but why spend the money just to do two connectors?

As noted earlier, these are the only leads that won't be #18 or #22. The Alternator lead will be #10 (up to 100 amps) and the battery leads are #2. Yes, it's heavy, so make sure to keep these short. The amount of power wasted heating up start cables can be significant with today's smaller batteries. It's really worth using the big cables, and putting the battery close to the engine. If you are using a turbine ask you're A&P about sizing starter leads. #2 works for just about everything else.

Coax Connectors

BNC connectors are about all you'll see in light airplanes. Anything else, follow the instructions or get a pro to help you. There's nothing magic about SMC, TNC or the rest, just no sense in beating yourself up to put on ONE oddball connector ONE time. You'll do a few BNCs, though, and here's what they look like:

The BNC – Digkey A24410-ND



A step, by step professional guide to attaching these can be found on the 'Net at:

<http://www.extron.com/download/files/userman/cabtermkit-man.pdf>

Learning To Solder

This is a better guide than I could write:

<http://www.circuittechctr.com/guides/7-1-1.shtml>

The only thing I'll add is that solder and shrink tube come as a pair. If you solder a lead, you have to put shrink tube over the connection to keep it from oxidizing, and most importantly to strain relieve it. Solder makes stranded wire solid, and solid wires crack and break under vibration. Apply shrink tube from the solder joint out to where the wire

is flexible (usually about an inch) and you'll have a connection that'll outlast the airframe.

Foolproof 100% Gonna Work Power System

Power Board Design

About 75% of the wiring in an airplane is the same whether you're flying an RV, Cozy or a 7E7. You've got to have a way to turn things on and off, a place to connect up all your avionics and a few places to hook up things that come up with the Master switch like the Alternator field and panel lights.

I figured the obvious thing to do was build a circuit board: one place to connect it all.

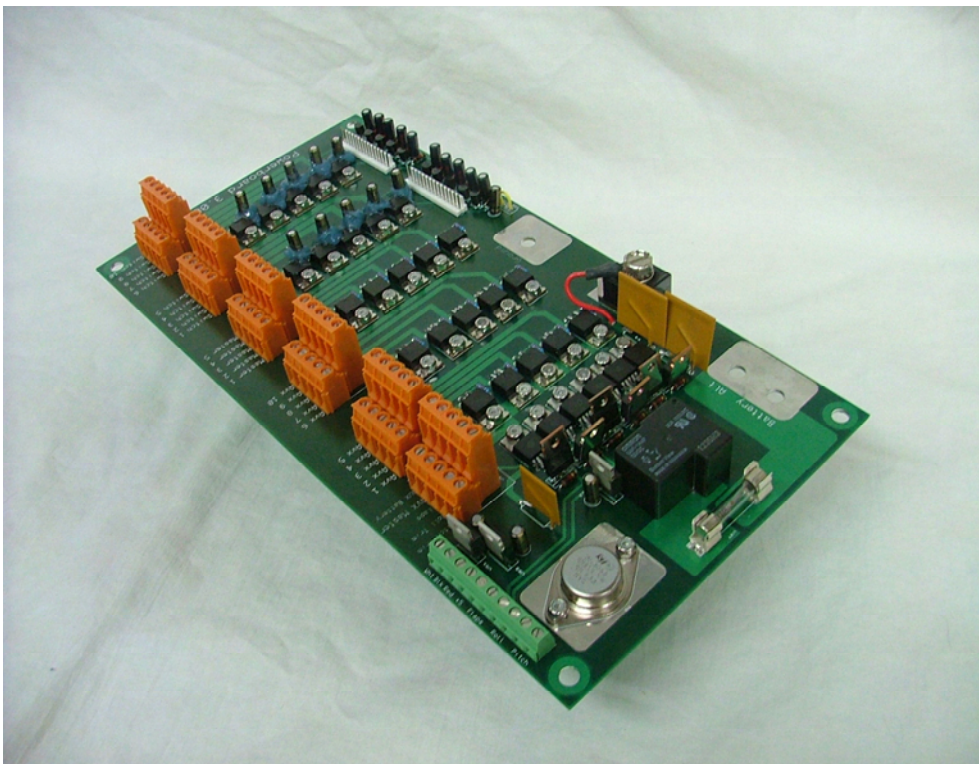

The concept of the Power Board is very simple: provide a place to connect almost everything electrical and connect it safely. The Power Board is extensively fused (circuit protected) with silicon over-current sensors and the main circuit is protected by a 50-amp Slow-Blow fuse. Everything connects to the Power Board except for your starter and high-current loads like HID lights.

The BMA Power Board provides the builder with a solid-state source of power distribution. We'll call the following circuits Master Circuits because they come up with the Master Switch.

Here's what we've got:

- Master switch and master relay
 - Five (5) circuits that come on with the Master switch on ship's power
 - Ten (10) switched circuits with provision for driving backlit switch/ indicators
 - Five (5) Avionics circuits
 - Five (5) Essential Avionics circuits with provision for backup battery
 - Reversing bridge for external Flap / Speed Brake switch
- 12 volt, 2 amp regulated power supply for Pitch and Roll trim motors. Really nice to have in a 24 volt ship.
 - Provision for connecting coolie hat to operate Pitch and Roll trim
- Runs on 10-32 volts DC
 - Main power bus is fused at 50 Amperes
 - All circuits individually protected by resettable solid-state over-current devices
 - The board is four (4) layers of 3 ounce copper, just so you know. It's designed for power.

The power board is very simple – everything connects to it including your Master switch and Alternator output, which should be wired separately on a breaker you can pull. Sometime you just might want to turn it off.

Here's how to wire it (and the airplane) step by step:

Mounting the board

Mount the circuit board on standoffs board using 1/4-28 machine screws and LocTite. I used a piece of plywood, but fiberglass is fine. Metal is asking for trouble here!

Master Switch and Ground

Connect your Master Switch to the appropriate terminals marked WHT, RED, BLK. The switch goes between the WHT and BLK leads, the RED is there to make the 5 volt light come on inside the switch.

Connect the battery to the powerboard at the pad marked BATTERY. This is a bolted, 1/4" screw connection. You'll use a #10 wire here, and also bolt a #10 to the GROUND pad at the back of the board. Solder on ring terminals, with heat shrink 2 inches long on each.

If you are using the MASTER relay that's on the board, you need to make SURE to fuse the lead coming from the battery. The battery is a store of tremendous energy, and if we're not going to mount the master relay right next to it, we need to make sure that it's not going to dump all that energy across an errant screwdriver or accidental short circuit. I like to bolt the fuseholder right next to the battery so the only unprotected leads in the plane are a few inches long.

NOTE: It's a good practice is to loop big leads into a small circle (3 inches or so) to keep them from putting stress of the board. I know you'll tie the leads down, but a loop is always good as a "spring" to take the force off the board and the soldered connection.

Alternator output

The Alternator output should be connected directly to the board through an appropriately sized fuse or circuit breaker. A fuse is a reasonable choice here since the only reason this would blow is if the Alternator was running away and going over voltage, or if there was a fault large enough to damage the alternator. Either way, it's not something you'd be likely to want to reset in flight.

I took DAR Robert Harris' advice of having a breaker you can pull, and I strongly suggest it. Until we cook up a foolproof over-voltage circuit, this is cheap insurance against a \$200 alternator taking out a \$20,000 panel. My best ideas usually come from other people.

Size this breaker or fuse for 1.25 times the rated Alternator output in Amperes.

Example: A 35 Amp alternator would get a $1.25 * 35 = 43.75$ amp fuse. 50 is the next closest size in circuit breakers, or a 45 Amp fuse would do it. Remember, a PTC fuse or breaker can't be counted on to hold above 80% of what it says on the nameplate; so a 50 Amp breaker may pop at 40 amps after 20 or 30 minutes. Just long enough into the flight to be a bother! Some places (like NASA) won't let you load up a fuse or breaker to more than 50% of its trip point. For a good primer on fuses, you can take a look at: <http://www.lnl.com/howto/fuse.htm> which is very readable if you really want to impersonate an engineer. You'd frankly be better of impersonating a physician or fighter pilot as I hear they get a lot more play.

Choosing Switches

Since the current draw is so low here, you can use almost anything that's aircraft-grade. I used the YB Series from NKK Switch in my airplane. They're a little pricey, but you can send the switch cap off to Precision Dial and have them lettered, and they look great. Blue LEDs look fantastic, although tradition demands green. Whatever you like best, just make sure the lights are 5 volts!

<http://nkkswitch.com> has a great selection of switches that'll look great on your panel.

The specs for the ones I used are: <http://www.nkkswitches.com/pdf/ybilluminated.pdf> and the actual part number is YB-25-RKG-01-6G-JB for the rectangular body, gold contacts, super bright blue LED with white cap. You can cook up your own switch by going to <http://www.nkkswitches.com/ConfiguratorIE.asp?S1=5007&S2=5057> and picking what you want. Digikey and Allied both carry NKK Switches.

Rectangular • Snap-in Mounting

Single & Double Pole

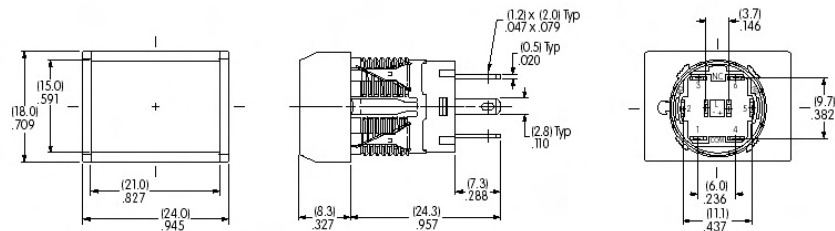

YB15NKW01-CB

Single pole models do not have terminals 4, 5, & 6.

PANEL THICKNESS & CUTOUTS

Bushing & Panel Seal Mount

Panel Thickness
0.5mm ~ 5.0mm
(.020" ~ .197")

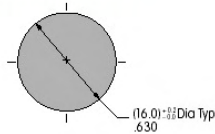

Snap-in Mount

Panel Thickness
1.0mm ~ 3.5mm
(.039" ~ .138")

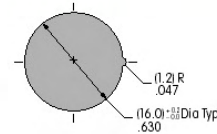

This Page Left Blank Because We Could

Where To Get Parts, Tools, Etc.

Digikey, at <http://digikey.com> has got everything you need in one place. Allied Electronics is also good at <http://alliedelec.com> , as is Mouser. Digikey has a great search feature on the Website that will really help you find things like “soldering iron” and shows you a list and pictures without having to know the part numbers.